

MADDEN

Centrifugal Blowdown Separators and Tanks

Centrifugal Blowdown Separators Selection Guide

To select the proper blowdown separator for your application, you need to know both the boiler operating pressure and the size of the bottom blowdown connection. Using those two figures, you can match the bottom blowdown inlet on the blowdown separator to the boiler blowdown connection size from the table on page 2. For example, the proper blowdown separator connection for a 125 psi boiler with a 1-1/2" bottom blowdown connection, you'll need part number BD230D45. The aftercooler size is determined by the size of the drain in the blowdown separator. The temperature regulating valve sizing is dependent on the cold water inlet on the aftercooler selected. For sizing on blowdown tanks, or for blowdown separators for boilers over 300 psi, contact the factory. All connections 2-1/2" and smaller are NPT, 3" and larger are 150 psi RF flanged. *See page 2 for the system drawing and dimensions.*

Data required: Blowdown Pipe Size 1-1/2" Boiler Pressure 250 psig

Blowdown Tanks

Blowdown tanks are used as an alternative system for cooling the bottom boiler blowdown. These large tanks retain the blowdown water volume from one blow after the flash steam has been vented to the atmosphere and allow the water to cool down by natural convection over a 6-12 hour period. The cooled water will be below 140° Fahrenheit when it is displaced by the next blowdown and forced out of the overflow drainpipe. *See page 4 for details of construction.*

Centrifugal Blowdown Separator Installation

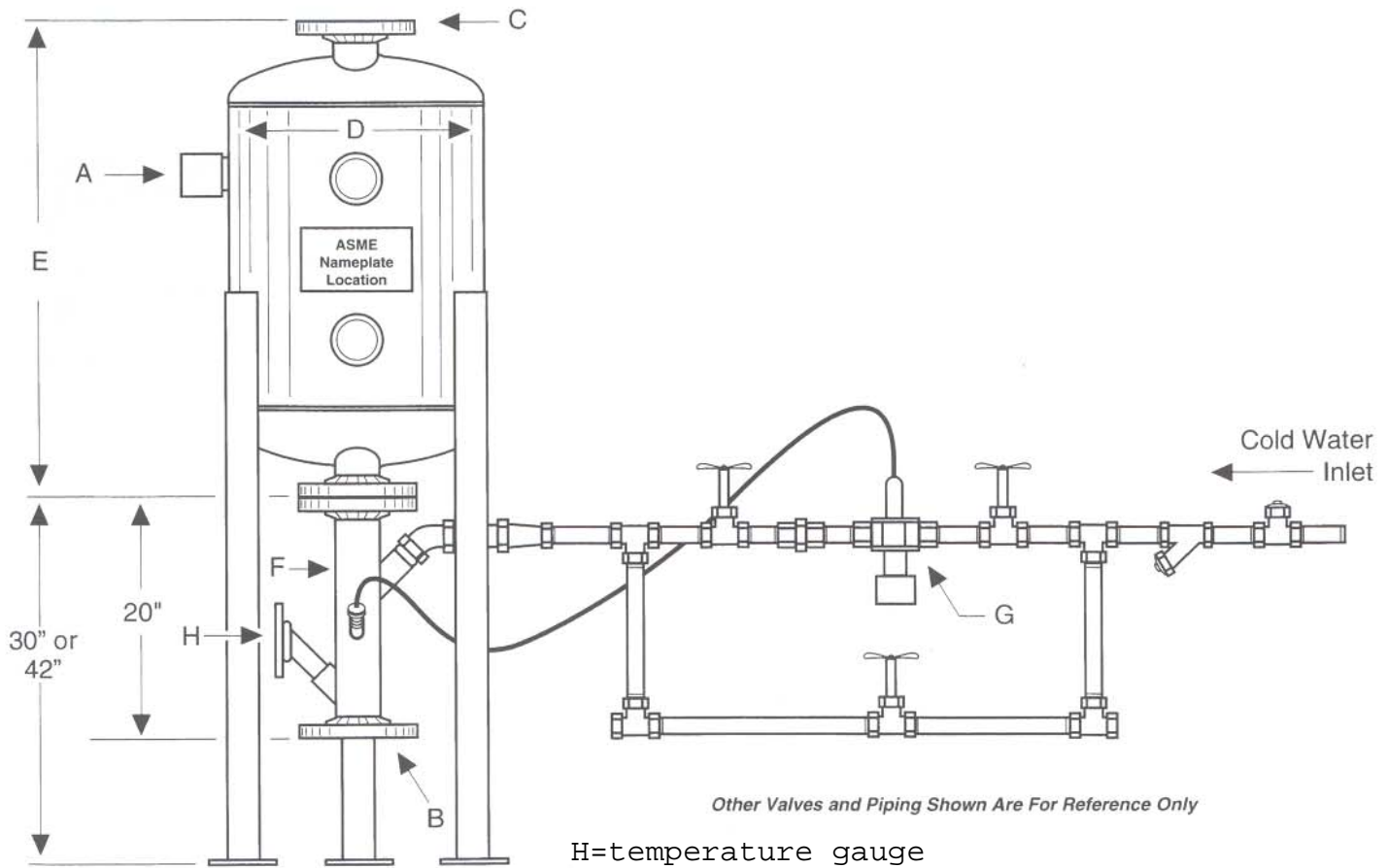

Blowdown Separator Part Number	Blowdown Inlet -A-	Blowdown Drain -B-	Blowdown Vent -C-	Vessel Diameter -D- x Height -E-	Aftercooler Part No. -F-	Cold Water Inlet Size	Aftercooler Size	Regulating Valve Number	Valve Size -G-
Boilers Up To 150 psi.									
BD130A22	3/4"	2-1/2"	2-1/2"	10" x 30"	AC200	3/4"	2-1/2"	AC102	3/4"
BD130B23	1"	2-1/2"	3"	10" x 30"	AC200	3/4"	2-1/2"	AC102	3/4"
BD230C44	1-1/4"	4"	4"	16" x 30"	AC400	1-1/4"	4"	AC104	1-1/4"
BD230D45	1-1/2"	4"	5"	16" x 30"	AC400	1-1/4"	4"	AC104	1-1/4"
BD230E55	2"	5"	5"	16" x 30"	AC500	1-1/2"	5"	AC105	1-1/2"
Boilers Up To 300 psi.									
BD242A34	3/4"	3"	4"	16" x 42"	AC300	1"	3"	AC103	1"
BD242B44	1"	4"	4"	16" x 42"	AC400	1-1/4"	4"	AC104	1-1/4"
BD242C45	1-1/4"	4"	5"	16" x 42"	AC400	1-1/4"	4"	AC104	1-1/4"
BD242D56	1-1/2"	5"	6"	16" x 42"	AC500	1-1/2"	5"	AC105	1-1/2"
BD242E68	2"	6"	8"	16" x 42"	AC600	1-1/2"	6"	AC105	1-1/2"

NOTE: Blowdown separators come with legs. Mounting brackets for attaching the blowdown separator to supporting structures provided by the owner are also available as an option.

Centrifugal Blowdown Separator

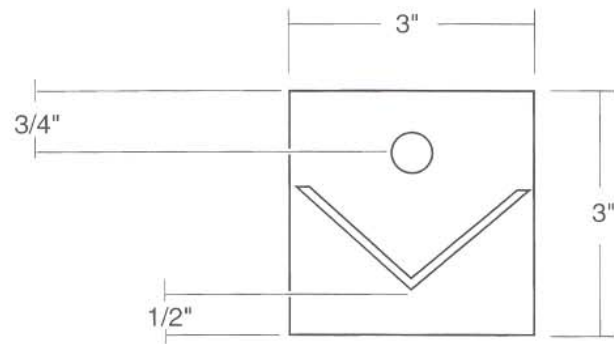
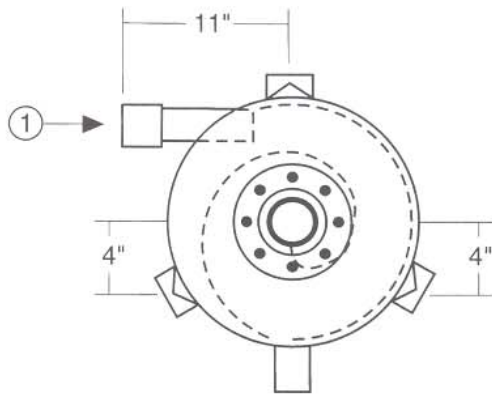

Leg Pad Detail
(Item #9)

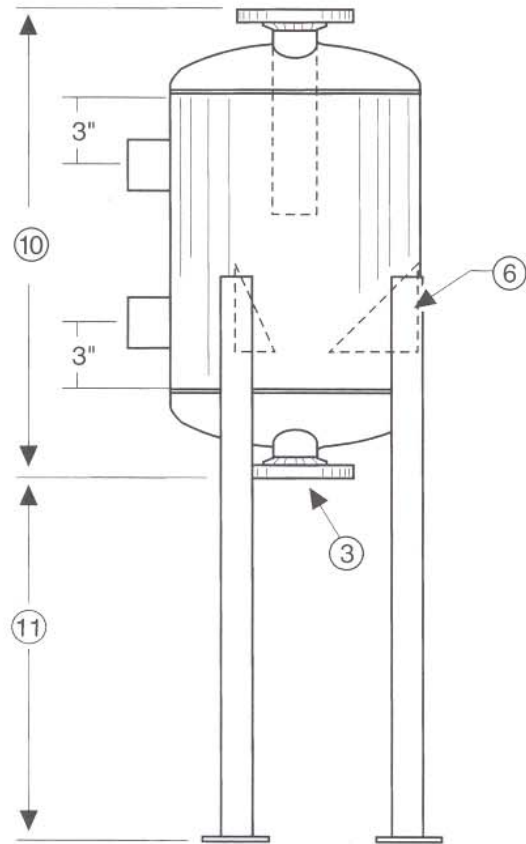
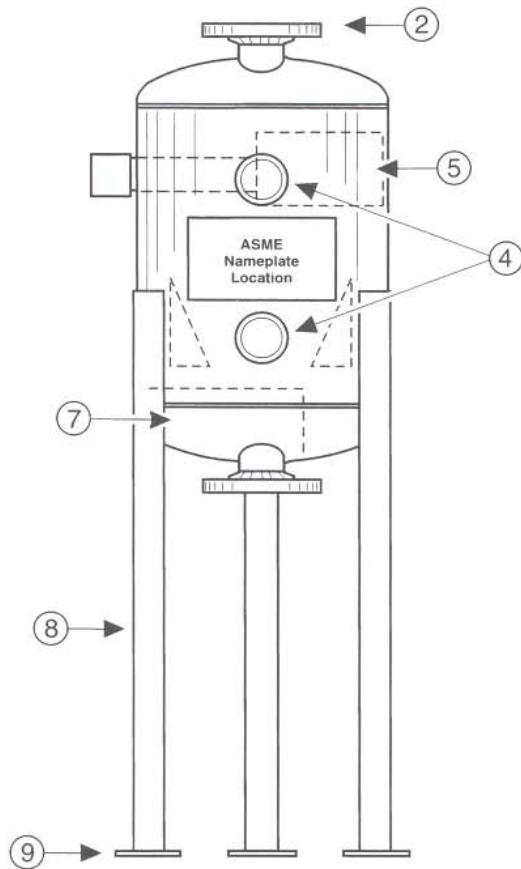

Item	Description
#1	1-1/2" NPTF Blowdown Inlet Connection
#2	6" _____ Vent Connection, 150 psi R.F. Flange
#3	5" _____ Drain Connection, 150 psi R.F. Flange
#4	2" NPTF Inspection Opening
#5	Impingement Plate, Stainless Steel
#6	Wall Baffle, Stainless Steel

Item	Description
#7	Spiral Baffle, Stainless Steel
#8	Legs with Foot Pad
#9	Foot Pad
#10	Vessel Height: _____ 30" _____ 42"
#11	Leg Height: _____ 30" _____ 42"

Bottom Blowdown Tanks

These heavy steel tanks receive the bottom blowdown water from a boiler and cool it down using the flash steam principle, along with convection cooling over several hours for the retained hot water. The tank is designed to breakup the blowdown flow by impacting the high pressure hot water on the steel centrifugal impact plate. The water droplets give up heat as flash steam is formed. The flash steam is vented from the top of the tank to the atmosphere. Retained water displaces cooled water from the previous blowdown, and is retained in the tank until it cools to the statute limits.

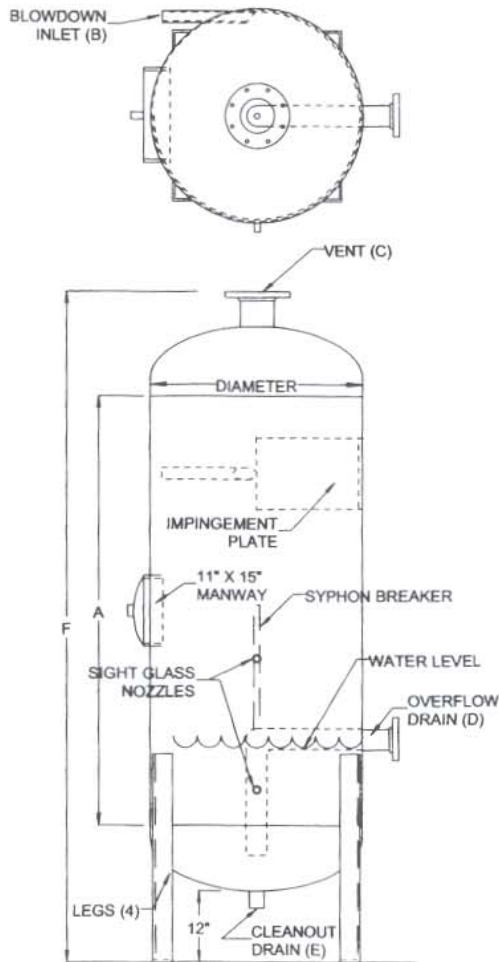

Data required for sizing calculations:

- Blowdown pipe size, type and equivalent length to tank.
- Boiler steam drum diameter & length.
- Boiler operating pressure.

Model Number	Shell Diameter	NPT A	NPT B	150 # RF Flange C	NPT D	NPT E	OAH F
BD3600	36"	30"	up to 2"	4"	3"	2"	70"
BD4200	42"	42"	up to 2"	5"	3"	2"	85"
BD4800	48"	48"	up to 2"	6"	4"	2"	94"
BD5400	54"	66"	up to 2"	6"	4"	2"	116"
BD6000	60"	72"	up to 2"	6"	4"	2"	125"
BD7200	72"	96"	up to 2"	10"	4"	2"	155"

- Shell length (Dimension A) and connections size dimensions can be changed to meet the application requirements for the specific boiler as determined by design rule calculations.
- Sizing of tank and connections should be determined using National Board design rules for blowoff tanks.
Contact the factory for assistance.
- Construction: ASME Section VIII, Div. 1, 50 psi DWP, with National Board serial number.

MADDEN

Manufacturing, Inc.
P.O. Box 387
1317 Princeton Blvd.
Elkhart, Indiana 46515



Sold By:

Phone (574) 295-4292
Fax (574) 295-7562
E-Mail: MADDENMFG@MSN.COM

Form BDS01

Contact your Sales Representative for detailed information on these other high quality Madden products: Diaphragm Metering Pumps, Chemical Feed Systems, Orifice Meters for Continuous Blowdown Controls and Sample Coolers.